



European Technical Approval ETA-08/0010

English translation prepared by DIBt - Original version in German language

Handelsbezeichnung
Trade name

fischer Reaktionsanker R
fischer Resin anchor R

Zulassungsinhaber
Holder of approval

fischerwerke GmbH & Co. KG
Otto-Hahn-Straße 15
79211 Denzlingen
DEUTSCHLAND

Zulassungsgegenstand
und Verwendungszweck

*Generic type and use
of construction product*

Verbunddübel in den Größen M8 bis M30 zur Verankerung im
ungerissenen Beton

*Bonded anchor in the size of M8 to M30 for use in
non-cracked concrete*

Geltungsdauer:
Validity:

vom
from

27 November 2008

bis
to

26 March 2013

verlängert
extended

vom
from

27 March 2013

bis
to

27 March 2018

Herstellwerk
Manufacturing plant

fischerwerke

Diese Zulassung umfasst
This Approval contains

27 Seiten einschließlich 18 Anhänge
27 pages including 18 annexes

I LEGAL BASES AND GENERAL CONDITIONS

- 1 This European technical approval is issued by Deutsches Institut für Bautechnik in accordance with:
 - Council Directive 89/106/EEC of 21 December 1988 on the approximation of laws, regulations and administrative provisions of Member States relating to construction products¹, modified by Council Directive 93/68/EEC² and Regulation (EC) N° 1882/2003 of the European Parliament and of the Council³;
 - *Gesetz über das In-Verkehr-Bringen von und den freien Warenverkehr mit Bauprodukten zur Umsetzung der Richtlinie 89/106/EWG des Rates vom 21. Dezember 1988 zur Angleichung der Rechts- und Verwaltungsvorschriften der Mitgliedstaaten über Bauprodukte und anderer Rechtsakte der Europäischen Gemeinschaften (Bauproduktengesetz - BauPG) vom 28. April 1998⁴, as amended by Article 2 of the law of 8 November 2011⁵;*
 - Common Procedural Rules for Requesting, Preparing and the Granting of European technical approvals set out in the Annex to Commission Decision 94/23/EC⁶;
 - Guideline for European technical approval of "Metal anchors for use in concrete - Part 5: Bonded anchors", ETAG 001-05.
- 2 Deutsches Institut für Bautechnik is authorized to check whether the provisions of this European technical approval are met. Checking may take place in the manufacturing plant. Nevertheless, the responsibility for the conformity of the products to the European technical approval and for their fitness for the intended use remains with the holder of the European technical approval.
- 3 This European technical approval is not to be transferred to manufacturers or agents of manufacturers other than those indicated on page 1, or manufacturing plants other than those indicated on page 1 of this European technical approval.
- 4 This European technical approval may be withdrawn by Deutsches Institut für Bautechnik, in particular pursuant to information by the Commission according to Article 5(1) of Council Directive 89/106/EEC.
- 5 Reproduction of this European technical approval including transmission by electronic means shall be in full. However, partial reproduction can be made with the written consent of Deutsches Institut für Bautechnik. In this case partial reproduction has to be designated as such. Texts and drawings of advertising brochures shall not contradict or misuse the European technical approval.
- 6 The European technical approval is issued by the approval body in its official language. This version corresponds fully to the version circulated within EOTA. Translations into other languages have to be designated as such.

¹ Official Journal of the European Communities L 40, 11 February 1989, p. 12
² Official Journal of the European Communities L 220, 30 August 1993, p. 1
³ Official Journal of the European Union L 284, 31 October 2003, p. 25
⁴ *Bundesgesetzblatt Teil I 1998*, p. 812
⁵ *Bundesgesetzblatt Teil I 2011*, p. 2178
⁶ Official Journal of the European Communities L 17, 20 January 1994, p. 34

II SPECIFIC CONDITIONS OF THE EUROPEAN TECHNICAL APPROVAL

1 Definition of the product and intended use

1.1 Definition of the construction product

The fischer Resin anchor R is a bonded anchor (injection type) consisting of a mortar capsule fischer RM and a steel element. The steel elements are either

- fischer anchor rods in the range of M8 to M30 or
- fischer internal threaded anchor RG MI in the range of M8 to M20 or

The steel element is placed into a drilled hole filled with injection mortar and is anchored via the bond between steel element, injection mortar and concrete.

An illustration of the product and intended use is given in Annexes 1

1.2 Intended use

The anchor is intended to be used for anchorages for which requirements for mechanical resistance and stability and safety in use in the sense of the Essential Requirements 1 and 4 of Council Directive 89/106 EEC shall be fulfilled and failure of anchorages made with these products would cause risk to human life and/or lead to considerable economic consequences. Safety in case of fire (Essential Requirement 2) is not covered in this European technical approval. The anchor is to be used only for anchorages subject to static or quasi-static loading in reinforced or unreinforced normal weight concrete of strength classes C20/25 at minimum and C50/60 at most according to EN 206:2000-12.

The anchor may be used in non-cracked concrete only.

The anchor may be used in dry or wet concrete and flooded holes excepting sea water. The anchor size M30 with standard cleaning may be used in dry or wet concrete; it must not to be installed in flooded holes.

The anchor may be used in the following service temperature ranges:

Temperature range I:	-40 °C to +80 °C	(max long term temperature +50 °C and max short term temperature +80 °C)
Temperature range II:	-40 °C to +120 °C	(max long term temperature +72 °C and max short term temperature +120 °C)

Elements made of zinc coated steel:

The element made of electroplated or hot-dipped galvanised steel may only be used in structures subject to dry internal conditions.

Elements made of stainless steel A4:

The element made of stainless steel may be used in structures subject to dry internal conditions and also in structures subject to external atmospheric exposure (including industrial and marine environment), or exposure in permanently damp internal conditions, if no particular aggressive conditions exist. Such particular aggressive conditions are e.g. permanent, alternating immersion in seawater or the splash zone of seawater, chloride atmosphere of indoor swimming pools or atmosphere with extreme chemical pollution (e.g. in desulphurization plants or road tunnels where de-icing materials are used).

Elements made of high corrosion resistant steel C:

The element made of high corrosion resistant steel may be used in structures subject to dry internal conditions and also in structures subject to external atmospheric exposure, in permanently damp internal conditions or in other particular aggressive conditions. Such particular aggressive conditions are e.g. permanent, alternating immersion in seawater or the splash zone of seawater, chloride atmosphere of indoor swimming pools or atmosphere with chemical pollution (e.g. in desulphurization plants or road tunnels where de-icing materials are used).

The provisions made in this European technical approval are based on an assumed working life of the anchor of 50 years. The indications given on the working life cannot be interpreted as a guarantee given by the producer, but are to be regarded only as a means for choosing the right products in relation to the expected economically reasonable working life of the works.

2 Characteristics of the product and methods of verification

2.1 Characteristics of product

The anchor corresponds to the drawings and provisions given in Annexes 1 to 3. The characteristic material values, dimensions and tolerances of the anchor not indicated in Annexes 1 to 3 shall correspond to the respective values laid down in the technical documentation⁷ of this European technical approval.

The characteristic anchor values for the design of anchorages are given in Annexes 6 to 18.

Each fischer mortar capsule RM shall be marked with the identifying mark of the manufacturer and with the trade name in accordance with Annex 1.

Each fischer anchor rod is marked with the property class in accordance with Annex 2.

Each fischer internal threaded anchor RG MI is marked with the marking of steel grade and length in accordance with Annex 2. Each fischer internal threaded anchor RG MI made of stainless steel is marked with the additional letter "A4". Each fischer internal threaded anchor RG MI made of high corrosion resistant steel is marked with the additional letter "C".

The marking of embedment depth may be done on jobsite.

2.2 Methods of verification

The assessment of fitness of the anchor for the intended use in relation to the requirements for mechanical resistance and stability and safety in use in the sense of the Essential Requirements 1 and 4 has been made in accordance with the "Guideline for European technical approval of Metal Anchors for use in concrete", Part 1 "Anchors in general" and Part 5 "Bonded anchors" on the basis of Option 7.

In addition to the specific clauses relating to dangerous substances contained in this European technical approval, there may be other requirements applicable to the products falling within its scope (e.g. transposed European legislation and national laws, regulations and administrative provisions). In order to meet the provisions of the Construction Products Directive, these requirements need also to be complied with, when and where they apply.

⁷ The technical documentation of this European technical approval is deposited at the Deutsches Institut für Bautechnik and, as far as relevant for the tasks of the approved bodies involved in the attestation of conformity procedure, is handed over to the approved bodies.

3 Evaluation and attestation of conformity and CE marking

3.1 System of attestation of conformity

According to the Decision 96/582/EG of the European Commission⁸ system 2(i) (referred to as System 1) of the attestation of conformity applies.

This system of attestation of conformity is defined as follows:

System 1: Certification of the conformity of the product by an approved certification body on the basis of:

- (a) Tasks for the manufacturer:
 - (1) factory production control;
 - (2) further testing of samples taken at the factory by the manufacturer in accordance with a prescribed control plan;
- (b) Tasks for the approved body:
 - (3) initial type-testing of the product;
 - (4) initial inspection of factory and of factory production control;
 - (5) continuous surveillance, assessment and approval of factory production control.

Note: Approved bodies are also referred to as "notified bodies".

3.2 Responsibilities

3.2.1 Tasks for the manufacturer

3.2.1.1 Factory production control

The manufacturer shall exercise permanent internal control of production. All the elements, requirements and provisions adopted by the manufacturer shall be documented in a systematic manner in the form of written policies and procedures, including records of results performed. This production control system shall insure that the product is in conformity with this European technical approval.

The manufacturer may only use initial/raw/constituent materials stated in the technical documentation of this European technical approval.

The factory production control shall be in accordance with the control plan which is part of the technical documentation of this European technical approval. The control plan is laid down in the context of the factory production control system operated by the manufacturer and deposited with Deutsches Institut für Bautechnik.⁹

The results of factory production control shall be recorded and evaluated in accordance with the provisions of the control plan.

3.2.1.2 Other tasks for the manufacturer

The manufacturer shall, on the basis of a contract, involve a body which is approved for the tasks referred to in section 3.1 in the field of anchors in order to undertake the actions laid down in section 3.2.2 For this purpose, the control plan referred to in sections 3.2.1.1 and 3.2.2 shall be handed over by the manufacturer to the approved body involved.

The manufacturer shall make a declaration of conformity, stating that the construction product is in conformity with the provisions of this European technical approval.

⁸ Official Journal of the European Communities L 254 of 08.10.1996

⁹ The control plan is a confidential part of the European technical approval and only handed over to the approved body involved in the procedure of attestation of conformity. See section 3.2.2.

3.2.2 Tasks for the approved bodies

The approved body shall perform the

- initial type-testing of the product,
- initial inspection of factory and of factory production control,
- continuous surveillance, assessment and approval of factory production control,

in accordance with the provisions laid down in the control plan.

The approved body shall retain the essential points of its actions referred to above and state the results obtained and conclusions drawn in a written report.

The approved certification body involved by the manufacturer shall issue an EC certificate of conformity of the product stating the conformity with the provisions of this European technical approval.

In cases where the provisions of the European technical approval and its control plan are no longer fulfilled the certification body shall withdraw the certificate of conformity and inform Deutsches Institut für Bautechnik without delay.

3.3 CE marking

The CE marking shall be affixed on each packaging of the anchor. The letters "CE" shall be followed by the identification number of the approved certification body, where relevant, and be accompanied by the following additional information:

- the name and address of the producer (legal entity responsible for the manufacture),
- the last two digits of the year in which the CE marking was affixed,
- the number of the EC certificate of conformity for the product,
- the number of the European technical approval,
- the number of the guideline for European technical approval,
- use category (ETAG 001-1, Option 7),
- size.

4 Assumptions under which the fitness of the product for the intended use was favourably assessed

4.1 Manufacturing

The European technical approval is issued for the product on the basis of agreed data/information, deposited with Deutsches Institut für Bautechnik, which identifies the product that has been assessed and judged. Changes to the product or production process, which could result in this deposited data/information being incorrect, should be notified to Deutsches Institut für Bautechnik before the changes are introduced. Deutsches Institut für Bautechnik will decide whether or not such changes affect the approval and consequently the validity of the CE marking on the basis of the approval and if so whether further assessment or alterations to the approval shall be necessary.

4.2 Design of anchorages

The fitness of the anchor for the intended use is given under the following conditions:

The anchorages are designed either in accordance with the

The anchorages are designed in accordance with

- EOTA Technical Report TR 029 "Design of bonded anchors"¹⁰
or in accordance with

- CEN/TS 1992-4:2009,

under the responsibility of an engineer experienced in anchorages and concrete work.

For the Fischer internal threaded anchor RG MI fastening screws or threaded rods made of appropriate steel and strength class acc. to Annex 3 shall be specified. The minimum and maximum thread engagement length l_E of the fastening screw or the threaded rod for installation of the fixture shall meet the requirements according to Annex 2, Table 1b. The length of the fastening screw or the threaded rod shall be determined depending on thickness of fixture, admissible tolerances, available thread length and minimum and maximum thread engagement length l_E .

Verifiable calculation notes and drawings are prepared taking account of the loads to be anchored.

The position of the anchor is indicated on the design drawings (e.g. position of the anchor relative to reinforcement or to supports, etc.).

4.3 Installation of anchors

The fitness for use of the anchor can only be assumed if the anchor is installed as follows:

- anchor installation carried out by appropriately qualified personnel and under the supervision of the person responsible for technical matters of the site,
- use of the anchor only as supplied by the manufacturer without exchanging the components of an anchor,
- anchor installation in accordance with the manufacturer's specifications and drawings using the tools indicated in the technical documentation of this European technical approval,
- commercial standard threaded rods, washers and hexagon nuts may also be used if the following requirements are fulfilled:
 - material, dimensions and mechanical properties of the metal parts according to the specifications given in Annex 3, Table 2,
 - confirmation of material and mechanical properties of the metal parts by inspection certificate 3.1 according to EN 10204:2004, the documents should be stored,
 - marking of the threaded rod with the envisaged embedment depth. This may be done by the manufacturer of the rod or the person on jobsite.
- checks before placing the anchor to ensure that the strength class of the concrete in which the anchor is to be placed is in the range given and is not lower than that of the concrete to which the characteristic loads apply,
- check of concrete being well compacted, e.g. without significant voids,
- marking and keeping the effective anchorage depth,
- edge distance and spacing not less than the specified values without minus tolerances,
- positioning of the drill holes without damaging the reinforcement,
- drilling by hammer drilling only,
- in case of aborted drill hole: the drill hole shall be filled with mortar,

¹⁰ The Technical Report TR 029 "Design of Bonded Anchors" is published in English on EOTA website www.eota.eu.

- cleaning the drill hole and anchor installation in accordance with manufacturers installation instructions given in Annex 5
- standard cleaning:
At least four times blowing operations with manual blow-out tool.
- premium cleaning:
At least four times blowing operations, four times brushing operations and again four times blowing operations. Blowing with manual blow-out tool; brushing operations by using the steel brush supplied by the manufacturer. Before brushing cleaning the brush and checking whether the brush diameter according to Annex 4, Table 4 is still sufficient,
- the mortar capsule is placed into the drilled hole; connecting the anchor rod with the percussion drill by using a corresponding adapter; driving the anchor rod or the internal threaded anchor into the mortar capsule by simultaneous hammering and turning of the drill; if the anchorage depth is achieved the drill must stopped immediately by using some pressure; if the anchor is proper installed mortar must be visible at the member surface.
 - The anchor component installation temperature shall be at least +5 °C; during curing of the injection mortar the temperature of the concrete must not fall below -5 °C; observing the curing time according to Annex 3 , Table 3 until the anchor may be loaded,
 - fastening screws or threaded rods (including nut and washer) for the internal threaded anchor must be made of appropriate steel grade and property class,
 - installation torque moments are not required for functioning of the anchor. However, the torque moments given in Annex 4 must not be exceeded.

5 Indications to the manufacture

5.1 Responsibility of the manufacturer

It is in the responsibility of the manufacturer to ensure that the information on the specific conditions according to 1 and 2 including Annexes referred to as well as sections 4.2, 4.3 and 5.2 is given to those who are concerned. This information may be made by reproduction of the respective parts of the European technical approval. In addition all installation data shall be shown clearly on the package and/or on an enclosed instruction sheet, preferably using illustration(s).

The minimum data required are:

- drill bit,
- hole depth,
- diameter of anchor rod,
- minimum effective anchorage depth,
- information on the installation procedure, including cleaning of the hole with the cleaning equipments, preferably by means of an illustration,
- anchor component installation temperature,
- material and property class of metal parts acc. to Annex 3, Table 2,
- ambient temperature of the concrete during installation of the anchor,
- admissible processing time (open time) of a cartridge,
- curing time until the anchor may be loaded as a function of the ambient temperature in the concrete during installation,
- maximum torque moment,
- identification of the manufacturing batch.

All data shall be presented in a clear and explicit form.

5.2 Packaging, transport and storage

The mortar cartridges and the capsules shall be protected against sun radiation and shall be stored according to the manufacturer instructions in dry condition at temperatures of at least +5 °C to not more than +25 °C.

Glass capsules with expired shelf life must no longer be used.

The anchor shall only be packaged and supplied as a complete unit. Glass capsules may be packed separately from metal parts.

The manufacturer's installation instruction shall indicate that the Glass capsules can be used only with the corresponding steel elements.

Georg Feistel
Head of Department

beglaubigt:
Baderschneider

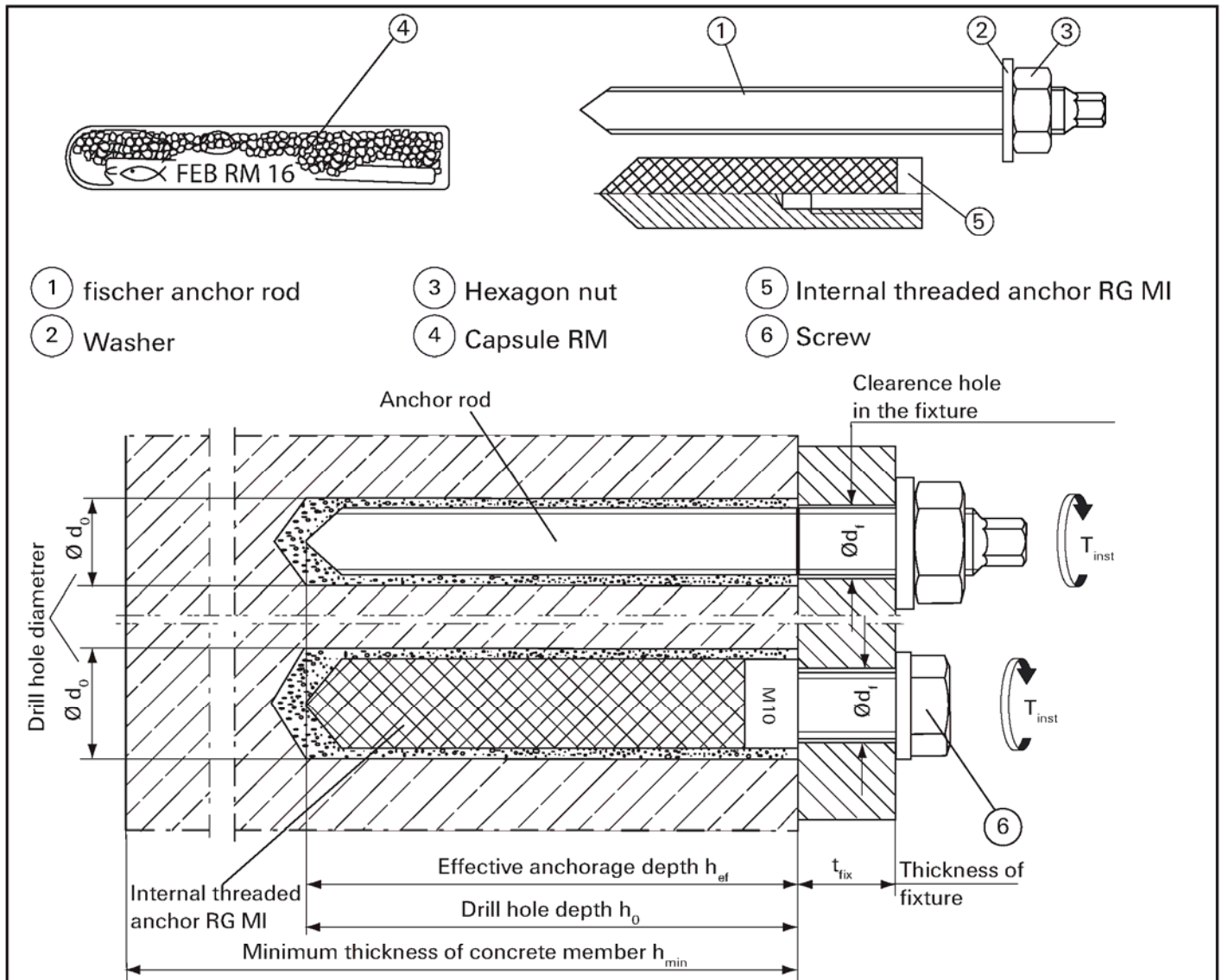

Table 1: Application range and intended use

	max. long term temperature	max. short term temperature	
Temperature range I: -40°C to +80°C	+50°C	+80°C	
Temperature range II: -40°C to +120°C	+72°C	+120°C	
Intended use	dry concrete	wet concrete	flooded hole
Anchor rods	M8 – M30		M8 – M27 ¹⁾ M30 ²⁾
Internal threaded anchors	M8 – M20 ²⁾		

¹⁾ Standard and premium cleaning process

²⁾ Only premium cleaning process

fischer Resin anchor R

Product and intended use
Application range and intended use

Annex 1

fischer anchor rod

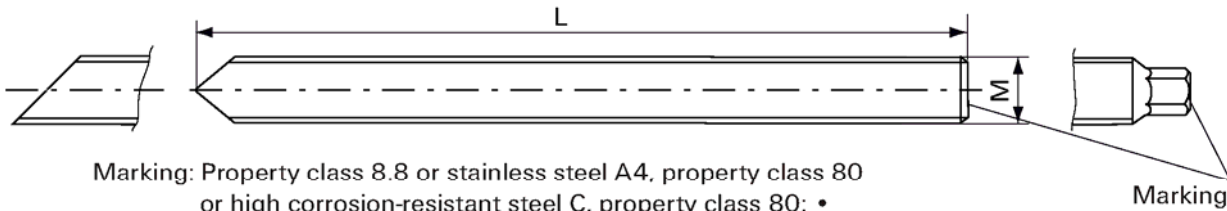

Marking: Property class 8.8 or stainless steel A4, property class 80
or high corrosion-resistant steel C, property class 80: •
Stainless steel A4, property class 50
or high corrosion-resistant steel C, property class 50: ••

Internal threaded anchor RG MI

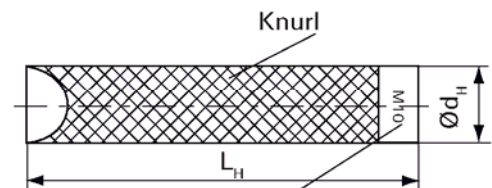
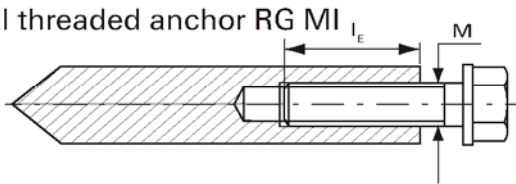

Mortar capsule RM

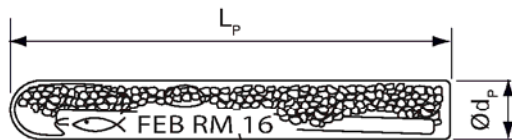

Marking: Work symbol, name, size

Marking:

Anchor size e.g.: **M10**

For stainless steel additional **A4**

e.g.: **M10 A4**

For high corrosion-resistant steel additional **C**

e.g.: **M10 C**

Table 1a: Dimensions of fischer anchor rods and capsules RM

Size	M8	M10	M12	M12E	M16	M16E	M20	M20E	M24	M24E	M27	M30
M [mm]	8	10	12		16		20		24		27	30
L ¹⁾ [mm]	90	100	130	170	150	215	195	270	240	320	280	315
h _{ef} [mm]	80	90	110	150	125	190	170	240	210	290	250	280
Capsule RM	8	10	12	12E	16	16E	20	20E	24	24E	27	30
Ø d _p [mm]	8	10,5	12,5		16,5		23				27,5	
L _p [mm]	85	90	97	120	95	123	160	215	190	250	210	260

¹⁾ Minimum length of anchor rods. Different lengths are possible.

Table 1b: Dimensions of internal threaded anchors RG MI and capsules RM

Size (M)	M8	M10	M12	M16	M20
Ø d _H [mm]	12	16	18	22	28
L _H = h _{ef} [mm]	90		125	160	200
l _E	l _{E,min} [mm]	8	10	12	16
	l _{E,max} [mm]	18	23	26	35
Capsule RM	12	14	16E	20	
Ø d _p [mm]	12,5	14,5	16,5	23	
L _p [mm]	97		123	160	

fischer Resin anchor R

Dimensions

Annex 2

Table 2: Materials

Designation	Materials		
	Steel, zinc plated	Stainless steel A4	High corrosion-resistant steel C
fischer anchor rod	Property class 5.8 or 8.8; EN ISO 898-1 zinc plated $\geq 5\mu\text{m}$, EN ISO 4042 A2K or hot-dip galvanised EN ISO 10684 $f_{uk} \leq 1000 \text{ N/mm}^2$ $A_5 > 8\%$	Property class 50, 70 or 80 EN ISO 3506 1.4401; 1.4404; 1.4578 1.4571; 1.4439; 1.4362 EN 10088 or 1.4062 pr EN 10088:2011 $f_{uk} \leq 1000 \text{ N/mm}^2$ $A_5 > 8\%$	Property class 50 or 80 EN ISO 3506 or property class 70 with $f_{yk} = 560 \text{ N/mm}^2$ 1.4565; 1.4529 EN 10088 $f_{uk} \leq 1000 \text{ N/mm}^2$ $A_5 > 8\%$
Washer EN ISO 7089	zinc plated $\geq 5\mu\text{m}$, EN ISO 4042 A2K or hot-dip galvanised EN ISO 10684	1.4401; 1.4404; 1.4578; 1.4571; 1.4439; 1.4362 EN 10088	1.4565; 1.4529 EN 10088
Hexagon nut EN ISO 4032	Property class 5 or 8 EN ISO 898-2 zinc plated $\geq 5\mu\text{m}$, EN ISO 4042 A2K or hot-dip galvanised EN ISO 10684	Property class 50; 70 or 80 EN ISO 3506 1.4401; 1.4404; 1.4578; 1.4571; 1.4439; 1.4362 EN 10088	Property class 50; 70 or 80 EN ISO 3506 1.4565; 1.4529 EN 10088
Screws and anchor rods for internal threaded anchors RG MI	Property class 5.8 or 8.8; EN ISO 898-1 zinc plated $\geq 5\mu\text{m}$, EN ISO 4042 A2K or hot-dip galvanised EN ISO 10684	Property class 70 EN ISO 3506 1.4401; 1.4404; 1.4578; 1.4571; 1.4439; 1.4362 EN 10088	Property class 70 EN ISO 3506-1 1.4565; 1.4529 EN 10088

Table 3: Curing times

Concrete temperature	minimum curing time ¹⁾ t_{cure}
- 5°C to - $\pm 0^\circ\text{C}$	4 h
$\geq 0^\circ\text{C}$ to +10°C	45 min
$\geq +10^\circ\text{C}$ to +20°C	20 min
$\geq +20^\circ\text{C}$	10 min

¹⁾ For wet concrete and flooded holes the curing times must be doubled.

fischer Resin anchor R

Materials
Curing times

Annex 3

Table 4: Installation parameters

fischer anchor rods												
Size	M8	M10	M12	M12 E	M16	M16 E	M20	M20 E	M24	M24 E	M27	M30
Nominal drill hole diameter d_o [mm]	10	12	14		18		25		28		32	35
Cutting diameter of drill bit d_{cut} [mm]	10,5	12,5	14,5		18,5		25,55		28,55		32,7	35,7
Depth of drill hole h_o [mm]	80	90	110	150	125	190	170	240	210	290	250	280
Diameter of clearance hole in the fixture $d_i \leq$ [mm]	9	12	14		18		22		26		30	33
Diameter of steel brush d_b [mm]	11	14	16		20		27		30		40	40
Max. torque moment $T_{inst,max}$ [Nm]	10	20	40		60		120		150		200	300
Thickness of fixture t_{fix}	min [mm]	0										
	max [mm]	1500										
Internal threaded anchors RG MI												
Size	M8	M10	M12	M16	M20							
Nominal drill hole diameter d_o [mm]	14	18	20	24	32							
Cutting diameter of drill bit d_{cut} [mm]	14,5	18,5	20,55	24,55	32,7							
Depth of drill hole h_o [mm]	90	90	125	160	200							
Diameter of clearance hole in the fixture $d_i \leq$ [mm]	9	12	14	18	22							
Diameter of steel brush d_b [mm]	16	20	25	26	40							
Max. torque moment $T_{inst,max}$ [Nm]	10	20	40	60	120							

Steel brush

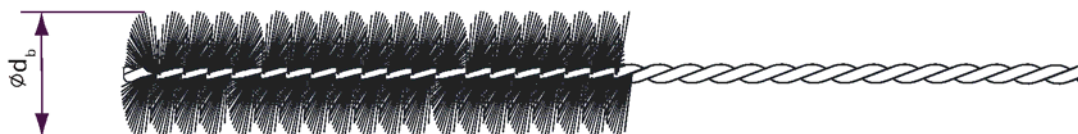



fischer Resin anchor R

Installation parameters

Annex 4

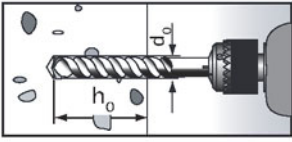
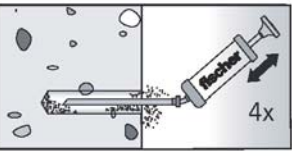
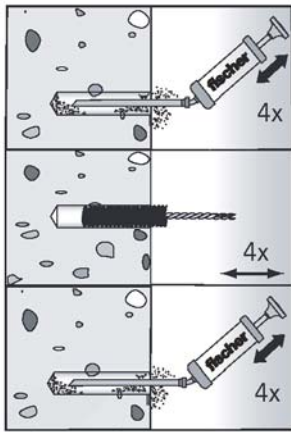
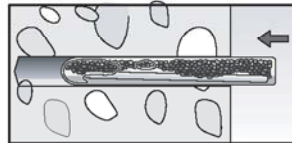
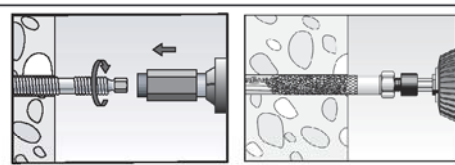
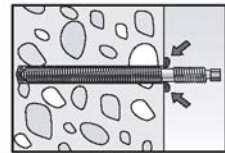
Mounting the fischer anchor rods and internal threaded anchors RG MI

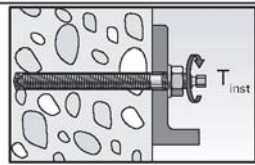
1		Drill hole; h_0 and d_0 see Table 4
2		Clean the hole Standard
2		Clean the hole Premium
3		Put the mortar capsule RM into the cleaned drill hole.
4		Mounting the fischer anchor rod/ the internal threaded anchor RG MI with an electric drilling mashine by using impact and rotation. Switch off drill immediately when reaching the drill hole base.
5		When reaching the drill hole base, surplus resin must be expelled.
		Do not touch (t_{cure} see Table 3) .
6		Mounting the fixture. Torque moment T_{inst} see Table 4.

fischer Resin anchor R

Installation instructions

Annex 5

Table 5: Minimum distance and minimum member thickness

fischer anchor rod							
Size		M8	M10	M12	M12 E	M16	M16 E
Effektive anchorage depth	h_{ef} [mm]	80	90	110	150	125	190
Minimum thickness of concrete member	h_{min} [mm]	110	120	150	200	160	250
Minimum edge distance and spacing	$s_{min} = c_{min}$ [mm]	40	45	55	75	65	95
Size		M20	M20E	M24	M24E	M27	M30
Effektive anchorage depth	h_{ef} [mm]	170	240	210	290	250	280
Minimum thickness of concrete member	h_{min} [mm]	220	300	280	380	330	370
Minimum edge distance and spacing	$s_{min} = c_{min}$ [mm]	85	120	105	145	125	140
Internal threaded anchor RG MI							
Size		M8	M10	M12	M16	M20	
Effektive anchorage depth	h_{ef} [mm]	90	90	125	160	200	
Minimum thickness of concrete member	h_{min} [mm]	120	120	170	220	270	
Minimum edge distance and spacing	$s_{min} = c_{min}$ [mm]	45	45	60	80	100	

fischer Resin anchor R

Minimum distances and
minimum member thickness

Annex 6

Table 6: Characteristic values of resistance to tension load for fischer anchor rods.
Design of Bonded Anchors acc. to TR 029 (Standard cleaning process)

Steel failure														
Size		M8	M10	M12	M12 E	M16	M16 E	M20	M20 E	M24	M24 E	M27	M30	
Characteristic resistance $N_{Rk,s}$	Property class	5.8 [kN]	19	30	44	82	127	183	239	292				
		8.8 [kN]	29	46	67	126	196	282	368	449				
	stainless steel A4 and steel C	Pro- perty class	50 [kN]	19	30	44	82	127	183	239	292			
		70 [kN]	26	41	59	110	172	247	322	393				
		80 [kN]	29	46	67	126	196	282	368	449				
Partial safety factor γ_{Ms} ¹⁾	Property class	5.8 [-]	1,50											
		8.8 [-]	1,50											
	stainless steel A4 and steel C	Pro- perty class	50 [-]	2,86										
		70 [-]	1,50 ⁴⁾ /1,87											
		80 [-]	1,60											
Combined pull-out and concrete cone failure														
Diameter for calculation	d [mm]	8	10	12	16	20	24	27	30					
Effective anchorage depth	h_{ef} [mm]	80	90	110	150	125	190	170	240	210	290	250	280	
Characteristic bond resistance in non-cracked concrete C20/25; use category: dry and wet concrete and flooded hole														
Temperature range I ⁵⁾	$\tau_{Rk,ucr}$ [N/mm ²]	8	7,5				6,5				6,5 ³⁾			
Temperature range II ⁵⁾	$\tau_{Rk,ucr}$ [N/mm ²]	6	7				6				6 ³⁾			
Increasing factors for $\tau_{Rk,ucr}$	Ψ_c	C25/30 [-]	1,06											
		C30/37 [-]	1,14											
		C35/45 [-]	1,22											
		C40/50 [-]	1,27											
		C45/55 [-]	1,31											
		C50/60 [-]	1,35											
Splitting failure														
Edge distance $c_{cr,sp}$ [mm]	$h / h_{ef} \geq 2,0$	1,0 h_{ef}												
	$2,0 > h / h_{ef} > 1,3$	4,6 h_{ef} - 1,8 h												
	$h / h_{ef} \leq 1,3$	2,26 h_{ef}												
Spacing	$s_{cr,sp}$ [mm]	2 $c_{cr,sp}$												
Partial safety factor	$\gamma_{Mp} = \gamma_{Mc} = \gamma_{Msp}$ ¹⁾ [-]	1,80 ²⁾												

¹⁾In absence of other national regulations.

²⁾The partial safety factor $\gamma_2 = 1,2$ is included.

³⁾Only use category: dry and wet concrete.

⁴⁾For steel C with: $f_{uk} = 700 \text{ N/mm}^2$; $f_{yk} = 560 \text{ N/mm}^2$

⁵⁾See Annex 1.

fischer Resin anchor R

Design of Bonded Anchor acc. to TR 029
Characteristic values to tension load for fischer anchor rods
Standard cleaning process / Spacing and edge distance

Annex 7

Table 7: Characteristic values of resistance to tension load for Fischer anchor rods.
Design of Bonded Anchor acc. to TR 029 (Premium cleaning process)

Steel failure														
Size		M8	M10	M12	M12 E	M16	M16 E	M20	M20 E	M24	M24 E	M27	M30	
Characteristic resistance $N_{Rk,s}$	Property class	5.8 [kN]	19	30	44	82	127	127	183	239	292			
		8.8 [kN]	29	46	67	126	196	196	282	368	449			
	stainless steel A4 and steel C	Property class	50 [kN]	19	30	44	82	127	183	239	292			
		70 [kN]	26	41	59	110	172	172	247	322	393			
Partial safety factor γ_{Ms}	Property class	5.8 [-]						1,50						
		8.8 [-]						1,50						
	stainless steel A4 and steel C	Property class	50 [-]						2,86					
		70 [-]						1,50 ⁵⁾ /1,87						
	80 [-]						1,60							
Combined pull-out and concrete cone failure														
Diameter for calculation	d [mm]	8	10	12		16		20		24		27	30	
Effective anchorage depth	h_{ef} [mm]	80	90	110	150	125	190	170	240	210	290	250	280	
Characteristic bond resistance in non-cracked concrete C20/25; use category: dry and wet concrete														
Temperature range I ⁶⁾	$\tau_{Rk,ucr}$ [N/mm ²]	11		10		9,5		9,0		8,5		8,0		
Temperature range II ⁶⁾	$\tau_{Rk,ucr}$ [N/mm ²]	10	9,5	8		7,5		7		6,5				
Characteristic bond resistance in non-cracked concrete C20/25; use category: flooded hole														
Temperature range I ⁶⁾	$\tau_{Rk,ucr}$ [N/mm ²]	9,0		10,0				9,5		9,0		8,5		
Temperature range II ⁶⁾	$\tau_{Rk,ucr}$ [N/mm ²]	8,0		9,0				8,5		8,0		7,5		
Increasing factors for $\tau_{Rk,ucr}$	Ψ_c	C25/30 [-]						1,06						
		C30/37 [-]						1,14						
		C35/45 [-]						1,22						
		C40/50 [-]						1,27						
		C45/55 [-]						1,31						
		C50/60 [-]						1,35						
Splitting failure														
Edge distance $c_{cr,sp}$ [mm]		$h / h_{ef} \geq 2,0$						1,0 h_{ef}						
		$2,0 > h / h_{ef} > 1,3$						4,6 h_{ef} - 1,8 h						
		$h / h_{ef} \leq 1,3$						2,26 h_{ef}						
Spacing	$s_{cr,sp}$ [mm]						2 $c_{cr,sp}$							
Partial safety factor $\gamma_{Mp} = \gamma_{Mc} = \gamma_{Msp}$ ¹⁾		dry and wet [-]	1,8 ²⁾						1,5 ³⁾					
		flooded hole [-]						2,1 ⁴⁾						

¹⁾In absence of other national regulations.
²⁾The partial safety factor $\gamma_2 = 1,2$ is included.
³⁾The partial safety factor $\gamma_2 = 1,0$ is included.
⁴⁾The partial safety factor $\gamma_2 = 1,4$ is included.
⁵⁾For steel C with: $f_{uk} = 700 \text{ N/mm}^2$; $f_{yk} = 560 \text{ N/mm}^2$
⁶⁾See Annex 1.

fischer Resin anchor R

Design of Bonded Anchor acc. to TR 029
 Characteristic values to tension load for Fischer anchor rods
 Premium cleaning process / Spacing and edge distance

Annex 8

Table 8: Characteristic values of resistance to shear load for fischer anchor rods
Design of Bonded Anchors, acc. to TR 029

Size		M8	M10	M12	M12 E	M16	M16 E	M20	M20 E	M24	M24 E	M27	M30	
Effective anchorage depth h_{ef} [mm]		80	90	110	150	125	190	170	240	210	290	250	280	
Steel failure without lever arm														
Charac-teris-tic resistance $V_{Rk,s}$	Property	5.8 [kN]	9	15	21	39	61	89	115	141	184	225	225	
	class	8.8 [kN]	15	23	34	63	98	141	184	225	280	340	420	
	stainless steel A4 and steel C	Pro- perty	50 [kN]	9	15	21	39	61	89	115	141	184	225	
		class	70 [kN]	13	20	30	55	86	124	161	197	250	310	
			80 [kN]	15	23	34	63	98	141	184	225	280	340	
Steel failure with lever arm														
Characteristic bending moment $M_{Rk,s}^0$	Property	5.8 [Nm]	19	37	65	166	324	561	833	1124	1415	1706	2107	
	class	8.8 [Nm]	30	60	105	266	519	896	1333	1797	2333	2900	3607	
	stainless steel A4 and steel C	Pro- perty	50 [Nm]	19	37	65	166	324	561	833	1124	1415	1706	
		class	70 [Nm]	26	52	92	232	454	784	1167	1573	2033	2533	
			80 [Nm]	30	60	105	266	519	896	1333	1797	2333	2900	
Partial safety factor for steel failure														
Partial safety factor $\gamma_{Ms}^{1)}$	Property	5.8 [-]	1,25											
	class	8.8 [-]	1,25											
	stainless steel A4 and steel C	Pro- perty	50 [-]	2,38										
		class	70 [-]	1,25 ³⁾ / 1,56										
			80 [-]	1,33										
Concrete pryout														
Factor in Equation (5.7) of TR 029, section 5.2.3.3	k [-]	2,0												
Partial safety factor $\gamma_{Mcp}^{1)}$ [-]		1,5 ²⁾												
Concrete edge failure see Technical Report TR 029, section 5.2.3.4														
Partial safety factor $\gamma_{Mc}^{1)}$ [-]		1,5 ²⁾												

¹⁾In absence of other national regulations

²⁾The partial safety factor $\gamma_2 = 1,0$ is included

³⁾For steel C with: $f_{uk} = 700 \text{ N/mm}^2$; $f_{yk} = 560 \text{ N/mm}^2$

fischer Resin anchor R

Design of Bonded Anchors, acc. to TR 029
Characteristic values to shear load
for fischer anchor rods

Annex 9

Table 9: Displacements of fischer anchor rods to tension load

Size	M8	M10	M12	M12 E	M16	M16 E	M20	M20 E	M24	M24 E	M27	M30
Tension load in non-cracked concrete N [kN]	10,5	14,8	19,7	26,9	29,9	45,5	48,3	68,2	67,9	93,7	90,9	106,8
Displacement δ_{N0} [mm/N/mm ²]	0,02					0,03					0,06	
Displacement $\delta_{N\infty}$ [mm/N/mm ²]	0,05					0,08					0,15	

Calculation of characteristic displacement with $\delta_N = (\delta_{N0} \cdot \tau_{Sd}) / 1,4$

Table 10: Displacements of fischer anchor rods to shear load

Size	M8	M10	M12	M12 E	M16	M16 E	M20	M20 E	M24	M24 E	M27	M30
Property class 5.8												
Displacement δ_{v0} [mm/kN]	0,45	0,25	0,2		0,1		0,06		0,05		0,04	0,03
Displacement $\delta_{v\infty}$ [mm/kN]	0,7	0,4	0,3		0,15		0,09		0,08		0,06	0,05
Property class 8.8												
Displacement δ_{v0} [mm/kN]	0,4	0,2	0,15		0,08		0,05		0,04		0,04	0,03
Displacement $\delta_{v\infty}$ [mm/kN]	0,6	0,3	0,22		0,12		0,07		0,06		0,06	0,04
A4 / C; property class 50												
Displacement δ_{v0} [mm/kN]	0,3	0,26	0,12		0,06		0,03		0,03		0,02	0,02
Displacement $\delta_{v\infty}$ [mm/kN]	0,45	0,4	0,18		0,09		0,04		0,04		0,03	0,03
A4 / C; property class 70 ¹⁾												
Displacement δ_{v0} [mm/kN]	0,4	0,25	0,2		0,09		0,06		0,05		0,04	0,03
Displacement $\delta_{v\infty}$ [mm/kN]	0,6	0,4	0,3		0,14		0,09		0,07		0,06	0,05
A4 / C; property class 80												
Displacement δ_{v0} [mm/kN]	0,4	0,2	0,15		0,08		0,05		0,04		0,04	0,03
Displacement $\delta_{v\infty}$ [mm/kN]	0,6	0,3	0,22		0,12		0,07		0,06		0,06	0,04

¹⁾ Steel C with $f_{uk} = 700 \text{ N/mm}^2$; $f_{yk} = 560 \text{ N/mm}^2$

Calculation of characteristic displacement with $\delta_v = (\delta_{v0} \cdot V_{Sd}) / 1,4$

fischer Resin anchor R

Displacements of fischer anchor rods

Annex 10

Table 11: Characteristic values of resistance to tension load for Internal threaded anchors RG MI
Design of bonded Anchor acc. to TR 029 (only permium cleaning process).

Size		M 8	M 10	M 12	M 16	M 20		
Steel failure								
Characteristic resistance with screw	$N_{Rk,s}$	Property-class	5.8 [kN]	19	29	43	79	123
			8.8 [kN]	29	47	68	108	179
		Property-class	A4 [kN]	26	41	59	110	172
			C [kN]	26	41	59	110	172
Partial safety factor	$\gamma_{Ms,N}^{1)}$	Property-class	5.8 [-]	1,50				
			8.8 [-]	1,50				
		Property-class	A4 [-]	1,87				
			C [-]	1,87				
Combined pullout and concrete failure								
Diameter for calculation	d_H [mm]	12	16	18	22	28		
Effective anchorage depth	h_{ef} [mm]	90	90	125	160	200		
Characteristic values in un-cracked concrete C20/25								
Intended use: dry and wet concrete								
Temperature range I (-40°C/+80°C) ⁴⁾	$N_{Rk,p}^0$ [kN]	30	356	50	75	115		
Temperature range II (-40°C/+120°C) ⁴⁾	$N_{Rk,p}^0$ [kN]	20	30	40	60	95		
Characteristic values in un-cracked concrete C20/25								
Intended use: flooded hole								
Temperature range I (-40°C/+80°C) ⁴⁾	$N_{Rk,p}^0$ [kN]	30	40	50	75	115		
Temperature range II (-40°C/+120°C) ⁴⁾	$N_{Rk,p}^0$ [kN]	25	35	50	60	115		
Increasing factors for $N_{Rk,p}^0$	ψ_c	C25/30 [-]	1,06					
		C30/37 [-]	1,14					
		C35/45 [-]	1,22					
		C40/50 [-]	1,27					
		C45/55 [-]	1,31					
		C50/60 [-]	1,35					
Splitting failure								
Edge distance $c_{cr,sp}$ [mm]	$h / h_{ef} \geq 2,0$	$1,0 h_{ef}$						
	$2,0 > h / h_{ef} > 1,3$	$4,6 h_{ef} - 1,8 h$						
	$h / h_{ef} \leq 1,3$	$2,26 h_{ef}$						
Spacing	$s_{cr,sp}$ [mm]	$2c_{cr,sp}$						
Partial safety factor $\gamma_{Mp} = \gamma_{Mc} = \gamma_{Msp}^{1)}$	dry and wet [-]	1,5 ²⁾						
	flooded hole [-]	2,1 ³⁾						

¹⁾In absence of other national regulations.

²⁾The partial factor $\gamma_2 = 1,0$ is included.

³⁾The partial factor $\gamma_2 = 1,2$ is included.

⁴⁾See Annex 1.

fischer Resin anchor R

Design of Bonded Anchor acc. to TR 029
Characteristic value to tension load for
internal threaded anchors RG MI

Annex 11

Table 12: Characteristic values of resistance to shear loads for internal threaded anchors RG MI.
Design of Bonded Anchor acc. to TR 029.

Size		M 8	M 10	M 12	M 16	M 20	
Steel failure without lever arm							
Characteristic resistance	$V_{Rk,s}$	Property 5.8 [kN]	9,2	14,5	21,1	39,2	62
		class 8.8 [kN]	14,6	23,2	33,7	62,7	90
		Property A4 [kN]	12,8	20,3	29,5	54,8	86
		class 70 C [kN]	12,8	20,3	29,5	54,8	86
Partial safety factor	$\gamma_{Ms,V}$	Property 5.8 [-]	1,25				
		class 8.8 [-]	1,25				1,5
		Property A4 [-]	1,56				
		class 70 C [-]	1,56				
Steel failure with lever arm							
Characteristic bending moment	$M_{Rk,s}^0$	Property 5.8[Nm]	20	39	68	173	337
		class 8.8[Nm]	30	60	105	266	519
		Property A4[Nm]	26	52	92	232	454
		class 70 C[Nm]	26	52	92	232	454
Partial safety factor	$\gamma_{Ms,V}$	Property 5.8 [-]	1,25				
		class 8.8 [-]	1,25				
		Property A4 [-]	1,56				
		class 70 C [-]	1,56				
Concrete pryout failure							
Factor k in Equation (5.7) of Technical Report TR 029, Section 5.2.3.3		k [-]	2,0				
Partial safety factor		$\gamma_{Mcp}^{1)}$ [-]	1,5 ²⁾				
Concrete edge failure		See Technical Report TR 029, Section 5.2.3.4					
Partial safety factor		$\gamma_{Mc}^{1)}$ [-]	1,5 ²⁾				

¹⁾ In absence of other national regulations.

²⁾ The partial safety factor $\gamma_2 = 1,0$ is included.

fischer Resin anchor R

Design of Bonded Anchor acc. to TR 029
Characteristic values to shear load for
internal threaded anchors RG MI

Annex 12

Table 13 : Displacements of internal threaded anchors RG MI to tension load

Size		M8	M10	M12	M16	M20
Tension load in non-cracked concrete	N [kN]	14,0	18,5	28,3	36,4	58,0
Displacement	δ_{v0} [mm]	0,2	0,30			
Displacement	$\delta_{v\infty}$ [mm]	0,5	0,75			

Calculation of characteristic displacement with $\delta_N = (\delta_{N0} \cdot \tau_{sd}) / 1,4$

Table 14 : Displacements of internal threaded anchors RG MI to shear load

Size		M8	M10	M12	M16	M20
Property class 5.8	Shear load V [kN]	5,3	8,5	12,3	22,8	35,7
Displacement	δ_{v0} [mm]	2,4		2,2		
Displacement	$\delta_{v\infty}$ [mm]	3,6		3,3		
Property class 8.8	Shear load V [kN]	8,2	13	18,9	35,1	51
Displacement	δ_{v0} [mm]	3,1	3,7	2,8		
Displacement	$\delta_{v\infty}$ [mm]	4,7		4,3		
A4; Property class 70	Shear load V [kN]	5,9	9,3	13,5	25,1	39,2
Displacement	δ_{v0} [mm]	2,3		2,4		
Displacement	$\delta_{v\infty}$ [mm]	3,4		3,6		
C; Property class 70	Shear load V [kN]	7,3	11,6	16,9	31,3	49
Displacement	δ_{v0} [mm]	2,8		3,0		
Displacement	$\delta_{v\infty}$ [mm]	4,3		4,5		

Calculation of characteristic displacement with $\delta_V = (\delta_{v0} \cdot V_{sd}) / 1,4$

fischer Resin anchor R

Displacements of internal threaded anchors RG MI

Annex 13

Table 15: Characteristic values of resistance to tension load for fischer anchor rod.
Design of Bonded Anchors acc. to CEN/TS 1992-4-5: 2009 (Standard cleaning process)

Steel failure														
Size		M8	M10	M12	M12 E	M16	M16 E	M20	M20 E	M24	M24 E	M27	M30	
Characteristic resistance $N_{Rk,s}$	Property class	5.8 [kN]	19	30	44	82	127	183	239	292				
		8.8 [kN]	29	46	67	126	196	282	368	449				
	stainless steel A4 and steel C	Pro- perty class	50 [kN]	19	30	44	82	127	183	239	292			
		70 [kN]	26	41	59	110	172	247	322	393				
	80 [kN]	29	46	67	126	196	282	368	449					
Partial safety factor γ_{Ms}	Property class	5.8 [-]	1,50											
		8.8 [-]	1,50											
	stainless steel A4 and steel C	Pro- perty class	50 [-]	2,86										
		70 [-]	1,50 ⁴⁾ /1,87											
	80 [-]	1,60												
Combined pull-out and concrete cone failure														
Diameter for calculation		d [mm]	8	10	12	16	20	24	27	30				
Effective anchorage depth		h_{ef} [mm]	80	90	110	150	125	190	170	240	210	290	250	280
Characteristic bond resistance in non-cracked concrete C20/25; use category: dry and wet concrete and flooded hole														
Temperature range I ⁵⁾		$\tau_{Rk,ucr}$ [N/mm ²]	8	7,5				6,5				6,5 ³⁾		
Temperature range II ⁵⁾		$\tau_{Rk,ucr}$ [N/mm ²]	6	7				6				6 ³⁾		
Factor for non-cracked concrete		k_{ucr} [-]	10,1											
Increasing factors for $\tau_{Rk,ucr}$	Ψ_c	C25/30 [-]	1,06											
		C30/37 [-]	1,14											
		C35/45 [-]	1,22											
		C40/50 [-]	1,27											
		C45/55 [-]	1,31											
		C50/60 [-]	1,35											
Splitting failure														
Edge distance $c_{cr,sp}$ [mm]	$h / h_{ef} \geq 2,0$		1,0 h_{ef}											
	$2,0 > h / h_{ef} > 1,3$		4,6 h_{ef} - 1,8 h											
	$h / h_{ef} \leq 1,3$		2,26 h_{ef}											
Spacing		$s_{cr,sp}$ [mm]	2 $c_{cr,sp}$											
Partial safety factor		$\gamma_{Mp} = \gamma_{Mc} = \gamma_{Msp}$ ¹⁾ [-]	1,80 ²⁾											

¹⁾In absence of other national regulations.

²⁾The partial safety factor $\gamma_2 = 1,2$ is included.

³⁾Only use category: dry and wet concrete.

⁴⁾For steel C with: $f_{uk} = 700 \text{ N/mm}^2$; $f_{yk} = 560 \text{ N/mm}^2$

⁵⁾See Annex 1.

Displacements see Annex 10.

fischer Resin anchor R

Design of Bonded Anchors acc. to CEN/ TS 1992-4-5:2009
Characteristic values to tension load for fischer anchor rods
Standard cleaning process/ Spacing and edge distance

Annex 14

Tabelle 16: Characteristic values of resistance to tension load for fischer anchor rods.
Design of Bonded Anchor acc. to CEN/TS 1992-4-5: 2009 (Premium cleaning process)

Steel failure														
Size		M8	M10	M12	M12 E	M16	M16 E	M20	M20 E	M24	M24 E	M27	M30	
Characteristic resistance $N_{Rk,s}$	Property class	5.8 [kN]	19	30	44	82	127	183	239	292				
		8.8 [kN]	29	46	67	126	196	282	368	449				
	stainless steel A4 and steel C	Pro- perty class	50 [kN]	19	30	44	82	127	183	239	292			
		70 [kN]	26	41	59	110	172	247	322	393				
		80 [kN]	29	46	67	126	196	282	368	449				
Partial safety factor $\gamma_{Ms}^{1)}$	Property class	5.8 [-]	1,50											
		8.8 [-]	1,50											
	stainless steel A4 and steel C	Pro- perty class	50 [-]	2,86										
		70 [-]	1,50 ⁵⁾ /1,87											
		80 [-]	1,60											
Combined pull-out and concrete cone failure														
Diameter for calculation d [mm]		8	10	12	16	20	24	27	30					
Effective anchorage depth h_{ef} [mm]		80	90	110	150	125	190	170	240	210	290	250	280	
Characteristic bond resistance in non-cracked concrete C20/25; use category: dry and wet concrete														
Temperature range I ⁶⁾ $\tau_{Rk,ucr}$ [N/mm ²]		11	10	9,5	9,0	8,5	8,0							
Temperature range II ⁶⁾ $\tau_{Rk,ucr}$ [N/mm ²]		10	9,5	8	7,5	7	6,5							
Characteristic bond resistance in non-cracked concrete C20/25; use category: flooded hole														
Temperature range I ⁶⁾ $\tau_{Rk,ucr}$ [N/mm ²]		9,0	10,0	9,5	9,0	8,5	8,0							
Temperature range II ⁶⁾ $\tau_{Rk,ucr}$ [N/mm ²]		8,0	9,0	8,5	8,0	7,5								
Factor for non-cracked concrete k_{ucr} [-]		10,1												
Increasing factors for $\tau_{Rk,ucr}$	Ψ_c	C25/30 [-]	1,06											
		C30/37 [-]	1,14											
		C35/45 [-]	1,22											
		C40/50 [-]	1,27											
		C45/55 [-]	1,31											
		C50/60 [-]	1,35											
Splitting failure														
Edge distance $c_{cr,sp}$ [mm]	$h / h_{ef} \geq 2,0$	1,0 h_{ef}												
	$2,0 > h / h_{ef} > 1,3$	4,6 h_{ef} - 1,8 h												
	$h / h_{ef} \leq 1,3$	2,26 h_{ef}												
Spacing $s_{cr,sp}$ [mm]		2 $c_{cr,sp}$												
Partial safety factor $\gamma_{Mp} = \gamma_{Mc} = \gamma_{Msp}^{1)}$	dry and wet [-]	1,8 ²⁾	1,5 ³⁾											
	flooded hole [-]	2,1 ⁴⁾												

¹⁾In absence of other national regulations.

²⁾The partial safety factor $\gamma_2 = 1,2$ is included.

³⁾The partial safety factor $\gamma_2 = 1,0$ is included.

⁴⁾The partial safety factor $\gamma_2 = 1,4$ is included.

⁵⁾For steel C with: $f_{uk} = 700 \text{ N/mm}^2$; $f_{yk} = 560 \text{ N/mm}^2$

⁶⁾See Annex 1.

Displacements see Annex 10.

fischer Resin anchor R

Design of Bonded Anchor acc. CEN/TS 1992-4-5: 2009
Characteristic values to tension load for fischer anchor rods
Premium cleaning process / Spacing and edge distance

Annex 15

Table 17: Characteristic values of resistance to shear load for fischer anchor rods
Design of Bonded Anchors, acc. to CEN/TS 1992-4-5: 2009

Size	M8	M10	M12	M12 E	M16	M16 E	M20	M20 E	M24	M24 E	M27	M30	
Effective anchorage depth h_{ef} [mm]	80	90	110	150	125	190	170	240	210	290	250	280	
Steel failure without lever arm													
Charac-teris-tic resistance $V_{Rk,s}$	Property	5.8 [kN]	9	15	21	39	61	89	115	141			
	class	8.8 [kN]	15	23	34	63	98	141	184	225			
	stainless steel A4 and steel C	Pro- perty	50 [kN]	9	15	21	39	61	89	115	141		
	class	70 [kN]	13	20	30	55	86	124	161	197			
	class	80 [kN]	15	23	34	63	98	141	184	225			
Steel failure with lever arm													
Characteristic bending moment $M_{Rk,s}^0$	Property	5.8 [Nm]	19	37	65	166	324	561	833	1124			
	class	8.8 [Nm]	30	60	105	266	519	896	1333	1797			
	stainless steel A4 and steel C	Pro- perty	50 [Nm]	19	37	65	166	324	561	833	1124		
	class	70 [Nm]	26	52	92	232	454	784	1167	1573			
	class	80 [Nm]	30	60	105	266	519	898	1333	1797			
Ductility factor k_2 [-]	0,8												
Partial safety factor for steel failure													
Partial safety factor $\gamma_{Ms}^{(1)}$	Property	5.8 [-]	1,25										
	class	8.8 [-]	1,25										
	stainless steel A4 and steel C	Pro- perty	50 [-]	2,38									
	class	70 [-]	1,25 ³⁾ / 1,56										
	class	80 [-]	1,33										
Concrete pryout													
Factor in Equation (27) of CEN/TS 1992-4-5, section 6.3.3	k_3 [-]	2,0											
Partial safety factor $\gamma_{Mcp}^{(1)}$ [-]	1,5 ²⁾												
Concrete edge failure see CEN/TS 1992-4-5, section 6.3.4													
Partial safety factor $\gamma_{Mc}^{(1)}$ [-]	1,5 ²⁾												

¹⁾In absence of other national regulations

²⁾The partial safety factor $\gamma_2 = 1,0$ is included

³⁾For steel C with: $f_{uk} = 700 \text{ N/mm}^2$; $f_{yk} = 560 \text{ N/mm}^2$

Displacements see Annex 10.

fischer Resin anchor R

Design of Bonded Anchors, acc. to CEN/TS 1992-4-5: 2009
Characteristic values to shear load
for fischer anchor rods

Annex 16

Table 18: Characteristic values of resistance to tension load for Internal threaded anchors RG MI. Design of bonded Anchor acc. CEN/TS 1992-4-5: 2009 (only permium cleaning process).

Size		M 8	M 10	M 12	M 16	M 20		
Steel failure								
Characteristic resistance with screw	$N_{Rk,s}$	Property-class	5.8 [kN]	19	29	43	79	123
			8.8 [kN]	29	47	68	108	179
		Property-class 70	A4 [kN]	26	41	59	110	172
			C [kN]	26	41	59	110	172
Partial safety factor	$\gamma_{Ms,N}^{1)}$	Property-class	5.8 [-]	1,50				
			8.8 [-]	1,50				
		Property-class 70	A4 [-]	1,87				
			C [-]	1,87				
Combined pullout and concrete failure								
Diameter for calculation	d_H [mm]	12	16	18	22	28		
Effective anchorage depth	h_{ef} [mm]	90	90	125	160	200		
Characteristic values in non-cracked concrete C20/25								
Intended use: dry and wet concrete								
Temperature range I (-40°C/+80°C) ⁴⁾	$N_{Rk,p}^0$ [kN]	30	35	50	75	115		
Temperature range II (-40°C/+120°C) ⁴⁾	$N_{Rk,p}^0$ [kN]	20	30	40	60	95		
Characteristic values in non-cracked concrete C20/25								
Intended use: flooded hole								
Temperature range I (-40°C/+80°C) ⁴⁾	$N_{Rk,p}^0$ [kN]	30	40	50	75	115		
Temperature range II (-40°C/+120°C) ⁴⁾	$N_{Rk,p}^0$ [kN]	25	35	50	60	115		
Factor for non-cracked concrete	k_{ucr} [-]	10,1						
Increasing factors for $N_{Rk,p}^0$	ψ_c	C25/30 [-]	1,06					
		C30/37 [-]	1,14					
		C35/45 [-]	1,22					
		C40/50 [-]	1,27					
		C45/55 [-]	1,31					
		C50/60 [-]	1,35					
Splitting failure								
Edge distance $c_{cr,sp}$ [mm]		$h / h_{ef} \geq 2,0$	1,0 h_{ef}					
		$2,0 > h / h_{ef} > 1,3$	4,6 h_{ef} - 1,8 h					
		$h / h_{ef} \leq 1,3$	2,26 h_{ef}					
Spacing	$s_{cr,sp}$ [mm]	2 $c_{cr,sp}$						
Partial safety factor $\gamma_{Mp} = \gamma_{Mc} = \gamma_{Msp}^{1)}$		dry and wet [-]	1,5 ²⁾					
		flooded hole [-]	2,1 ³⁾					

¹⁾In absence of other national regulations.

²⁾The partial factor $\gamma_2 = 1,0$ is included.

³⁾The partial factor $\gamma_2 = 1,2$ is included.

⁴⁾See Annex 1.

Displacements see Annex 13

fischer Resin anchor R

Design of Bonded Anchor acc. CEN/TS 1992-4-5: 2009
Characteristic value to tension load for
internal threaded anchors RG MI

Annex 17

Table 19: Characteristic values of resistance to shear loads for internal threaded anchors RG MI. Design of Bonded Anchor acc. to CEN/TS 1992-4-5: 2009.

Size		M 8	M 10	M 12	M 16	M 20	
Steel failure without lever arm							
Characteristic resistance	$V_{Rk,s}$	Property class 5.8 [kN]	9,2	14,5	21,1	39,2	62
		Property class 8.8 [kN]	14,6	23,2	33,7	62,7	90
		Property class A4 [kN]	12,8	20,3	29,5	54,8	86
		Property class 70 C [kN]	12,8	20,3	29,5	54,8	86
Partial safety factor	$\gamma_{Ms,v}$	Property class 5.8 [-]	1,25				
		Property class 8.8 [-]	1,25				1,5
		Property class A4 [-]	1,56				
		Property class 70 C [-]	1,56				
Steel failure with lever arm							
Characteristic bending moment	$M_{Rk,s}^0$	Property class 5.8 [Nm]	20	39	68	173	337
		Property class 8.8 [Nm]	30	60	105	266	519
		Property class A4 [Nm]	26	52	92	232	454
		Property class 70 C [Nm]	26	52	92	232	454
Ductility factor	k_2 [-]	0,8					
Partial safety factor	$\gamma_{Ms,v}$	Property class 5.8 [-]	1,25				
		Property class 8.8 [-]	1,25				
		Property class A4 [-]	1,56				
		Property class 70 C [-]	1,56				
Concrete pryout failure							
Factor in Equation (27) CEN/TS 1992-4-5, Section 6.3.3	k_3 [-]	2,0					
Partial safety factor	$\gamma_{Mcp}^{1)}$ [-]	1,5 ²⁾					
Concrete edge failure							
Partial safety factor	$\gamma_{Mc}^{1)}$ [-]	1,5 ²⁾					

¹⁾ In absence of other national regulations.

²⁾ The partial safety factor $\gamma_2 = 1,0$ is included.

Displacements see Annex 13.

fischer Resin anchor R

Design of Bonded Anchor acc. to CEN/TS 1992-4-5: 2009
Characteristic values to shear load for
internal threaded anchors RG MI

Annex 18