

## fischer SystemOne

### Product description

- Aluminium rainscreen cladding support systems

### Advantages / benefits

- Strong closed section aluminium profiles for high loads
- Spanning of non-load bearing areas
- Adjustability in all directions
- Installation regardless of weather
- Pre-assembly possible
- Modular flexibility
- Max. corrosion resistance

### Installation

- Subframe support systems have to be designed and installed according to valid specifications as well as national codes and regulations.

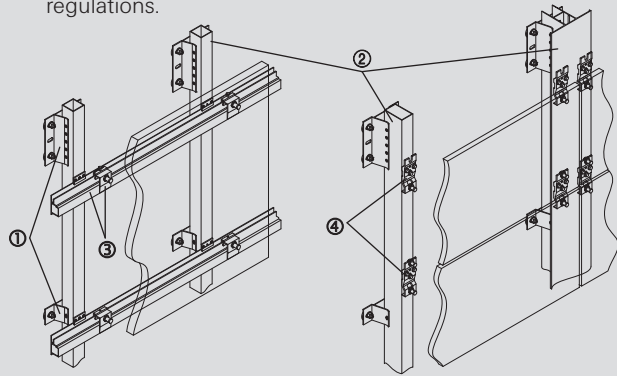

### Application examples

#### ■ Bracket Solution BS

e.g. with granite stone slab



#### ■ Bracket SolutionLight BSL

e.g. with ceramic panel

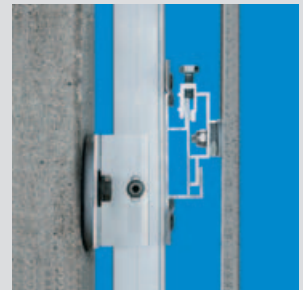

#### ■ Vertical Solution

e.g. with FZP Carbon and reveal angle

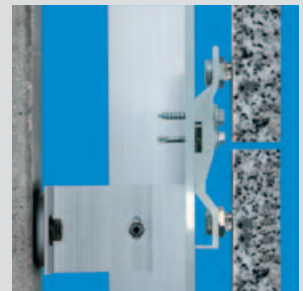

### Technical Details

#### ① Wall holders

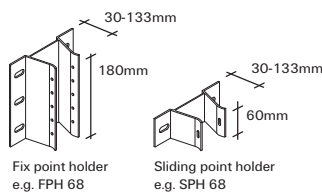

#### ② Vertical profiles

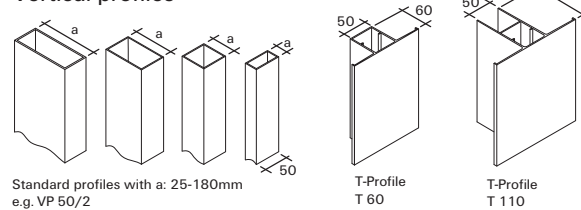

#### ③ Bracket Solution

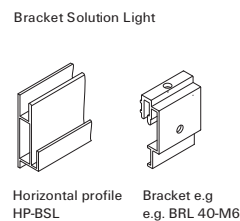
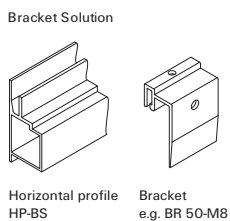

#### ④ Vertical Solution

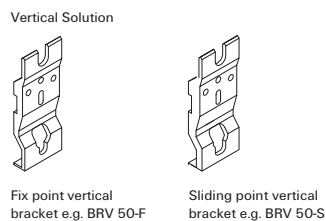

Details on request.

### ACT Service

fischerwerke GmbH & Co. KG

Werk Altheim · Hindenburgstr. 81 · D-72160 Horb

Phone +49 (0)74 43 12-45 53 · Fax +49 (0)74 43 12-49 07

act@fischer.de · www.fischer.de